

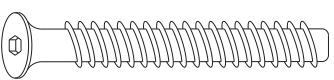
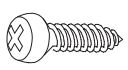
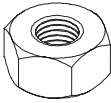
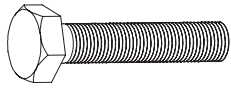

A x 4  Ø10x40mm

E x 2  Ø7,0x50mm

B x 8  Ø4,0x14mm

F x 2 

C x 2 

G x 8 

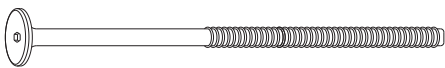
D x 8  Ø1,4x130mm

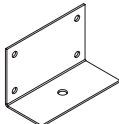
H x 2 

I x 1 

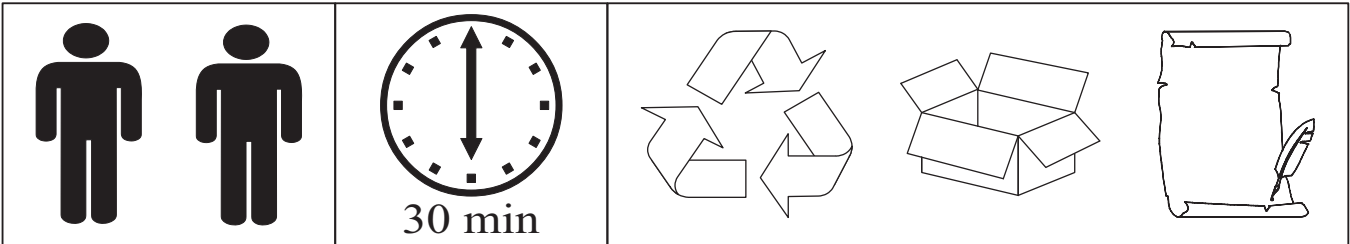
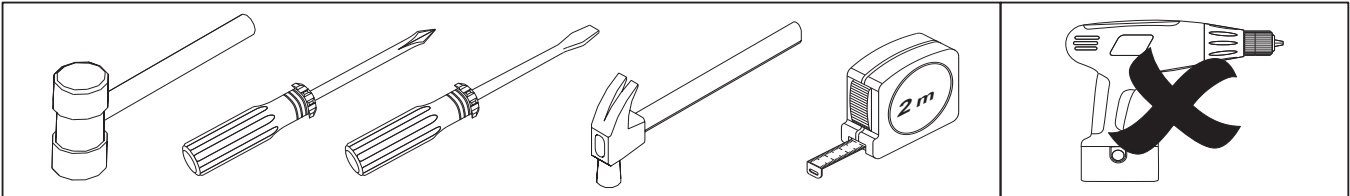

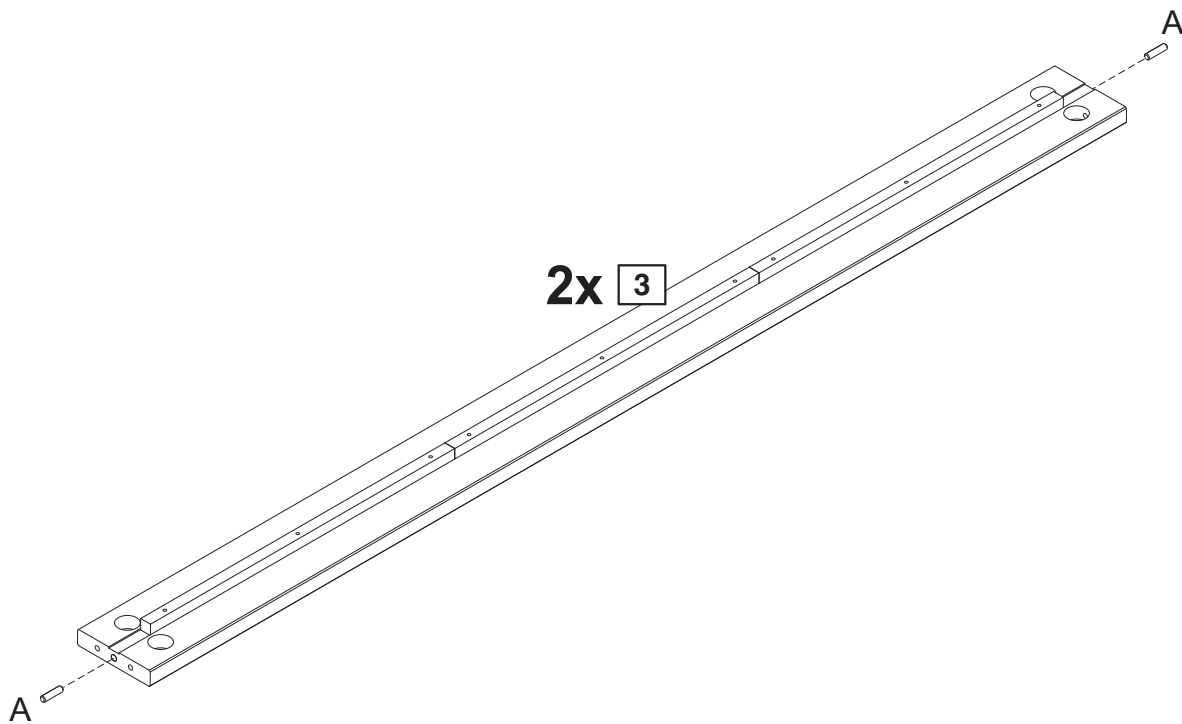
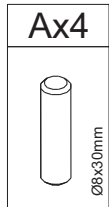

1

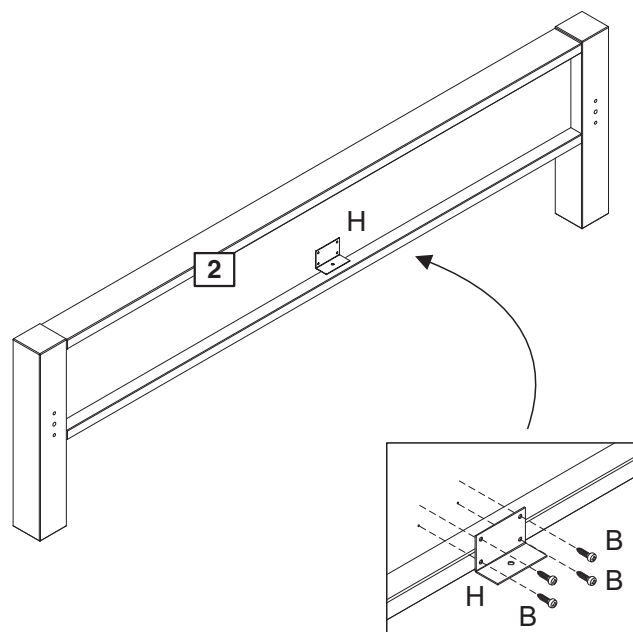
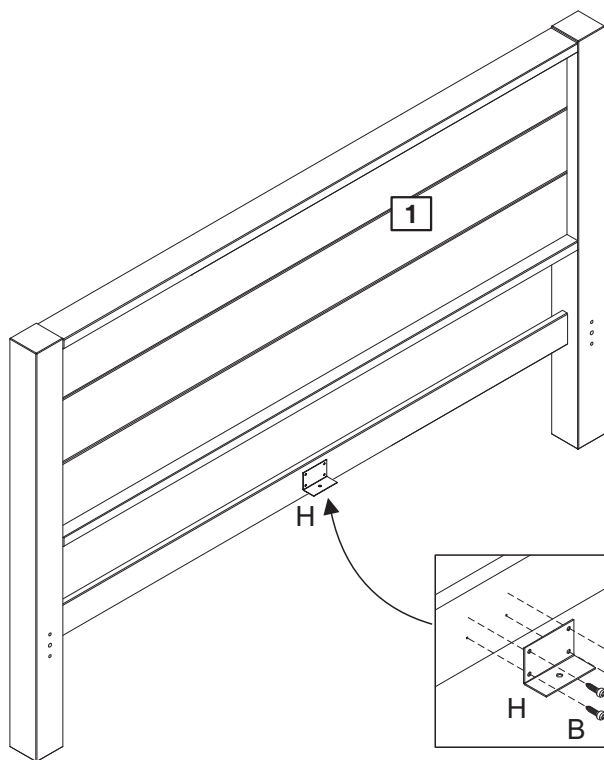
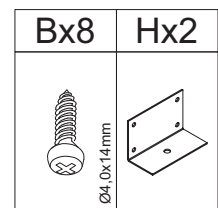

2



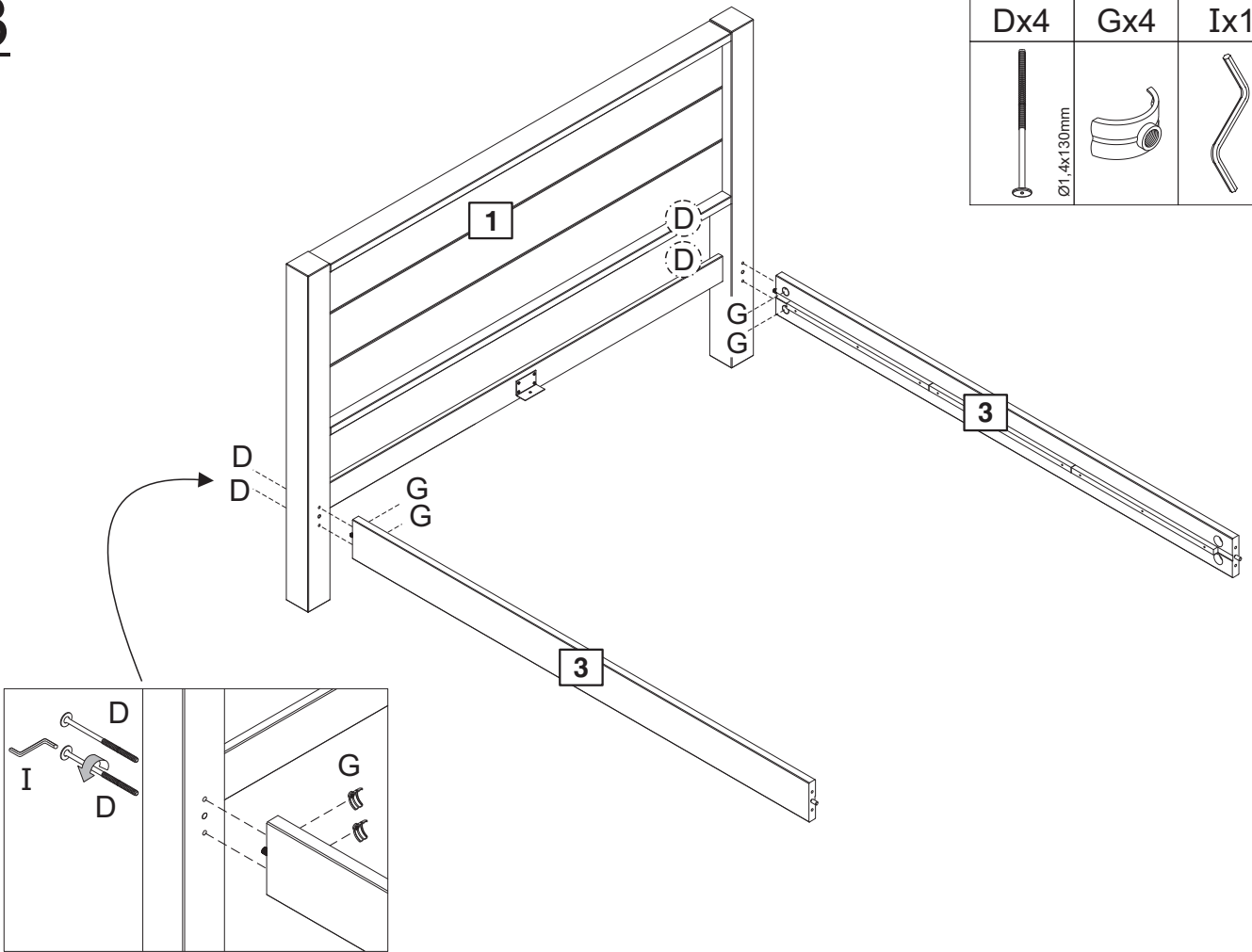

3

Dx4	Gx4	Ix1
		
$\varnothing 1,4 \times 130 \text{mm}$		



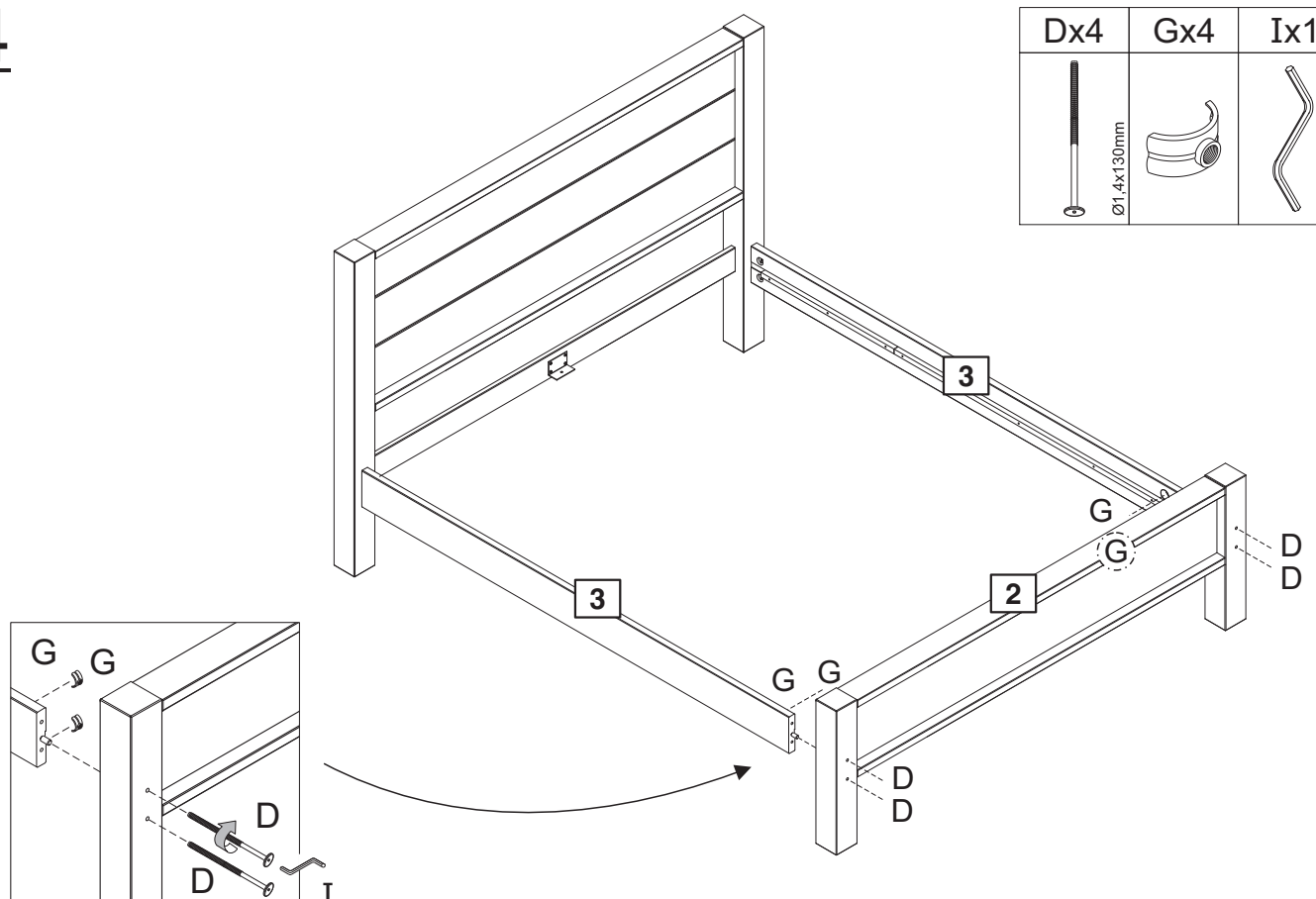

4

Dx4	Gx4	Ix1
		
$\varnothing 1,4 \times 130 \text{mm}$		



5

Ex2	Ix1
	
Ø7,0x50mm	

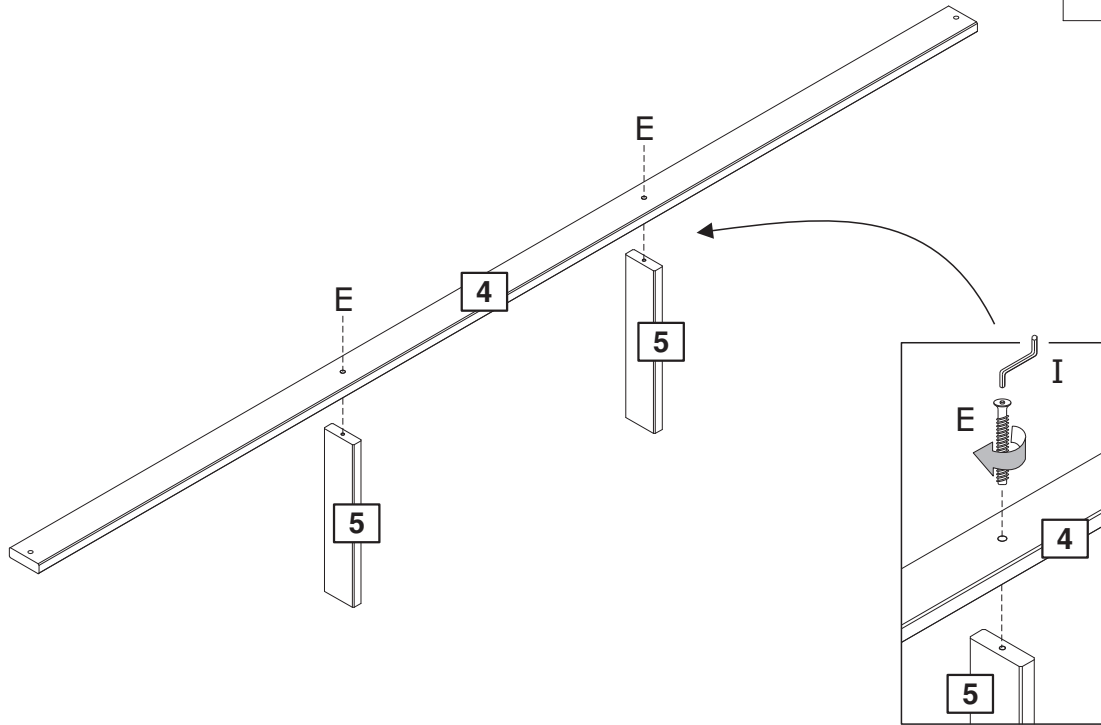

6

Cx2	Fx2
