





A x 36  Ø8x30mm

G x 8 

B x 16  Ø3,5x14mm

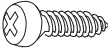
H x 8 

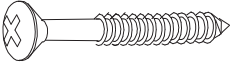
C x 8  Ø3,5x30mm

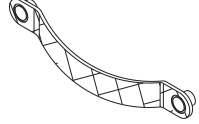
I x 2 

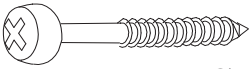
D x 2  Ø4,0x35mm

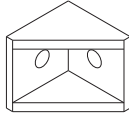
J x 8 

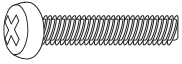
E x 4  ØM4x16mm

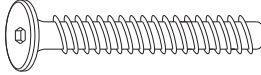
K x 4  Ø7,0x90mm

F x 16 

L x 1 

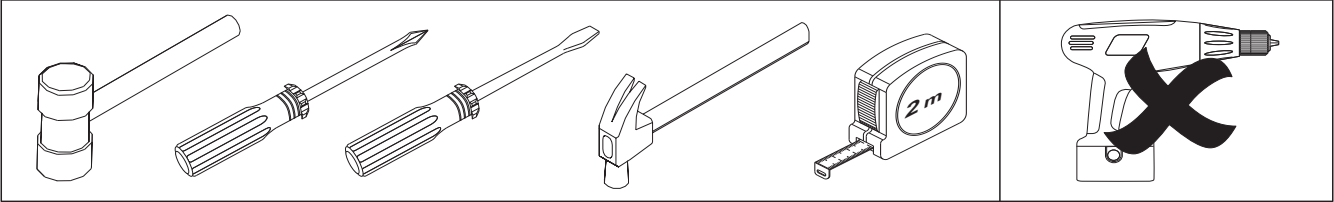

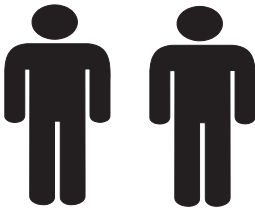
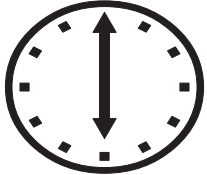
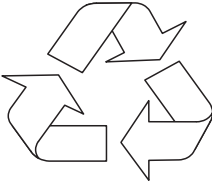
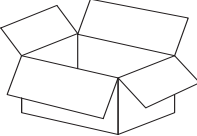
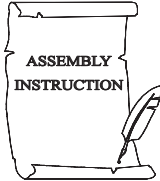

 50 min
 



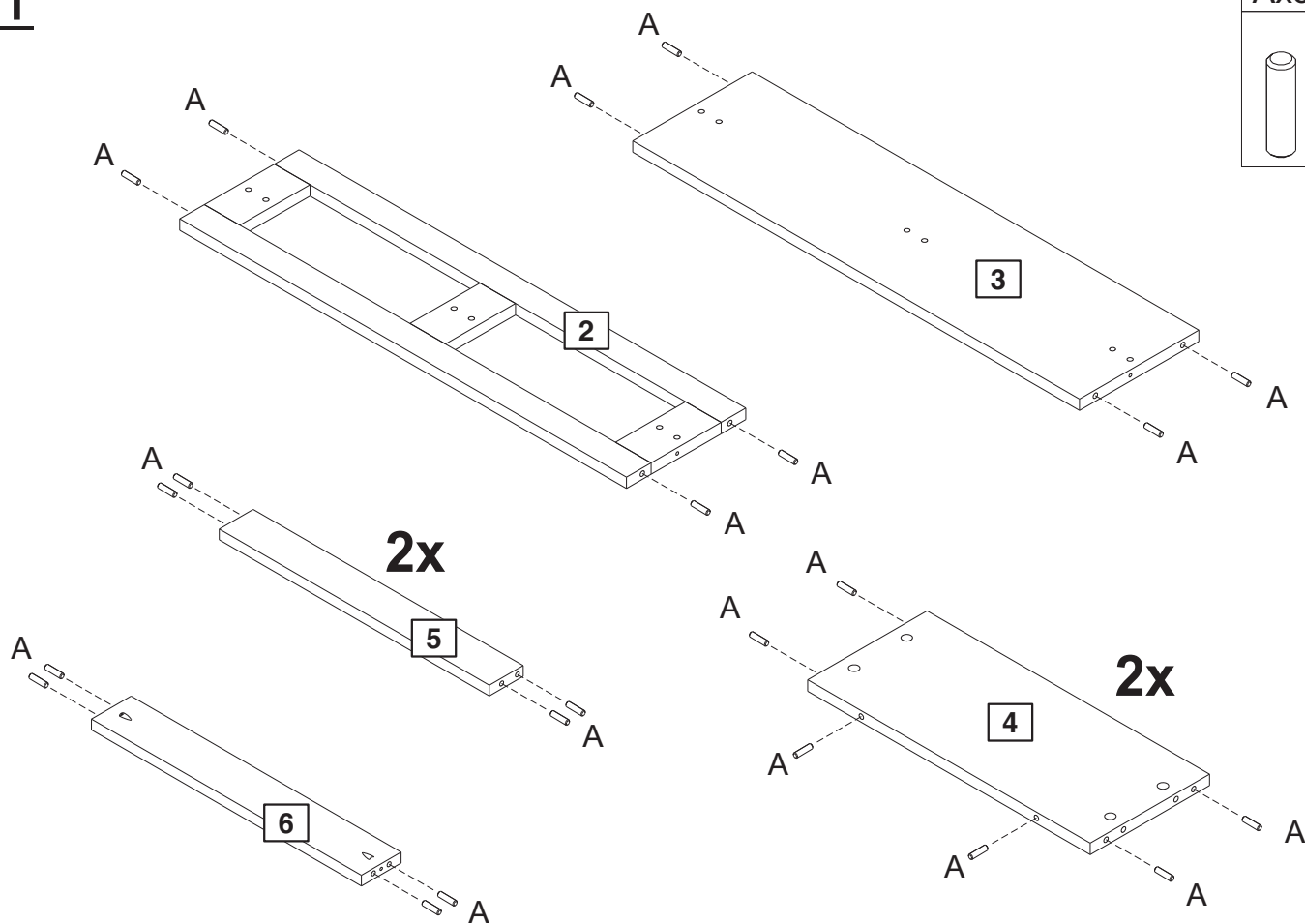
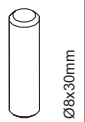

1

Ax32



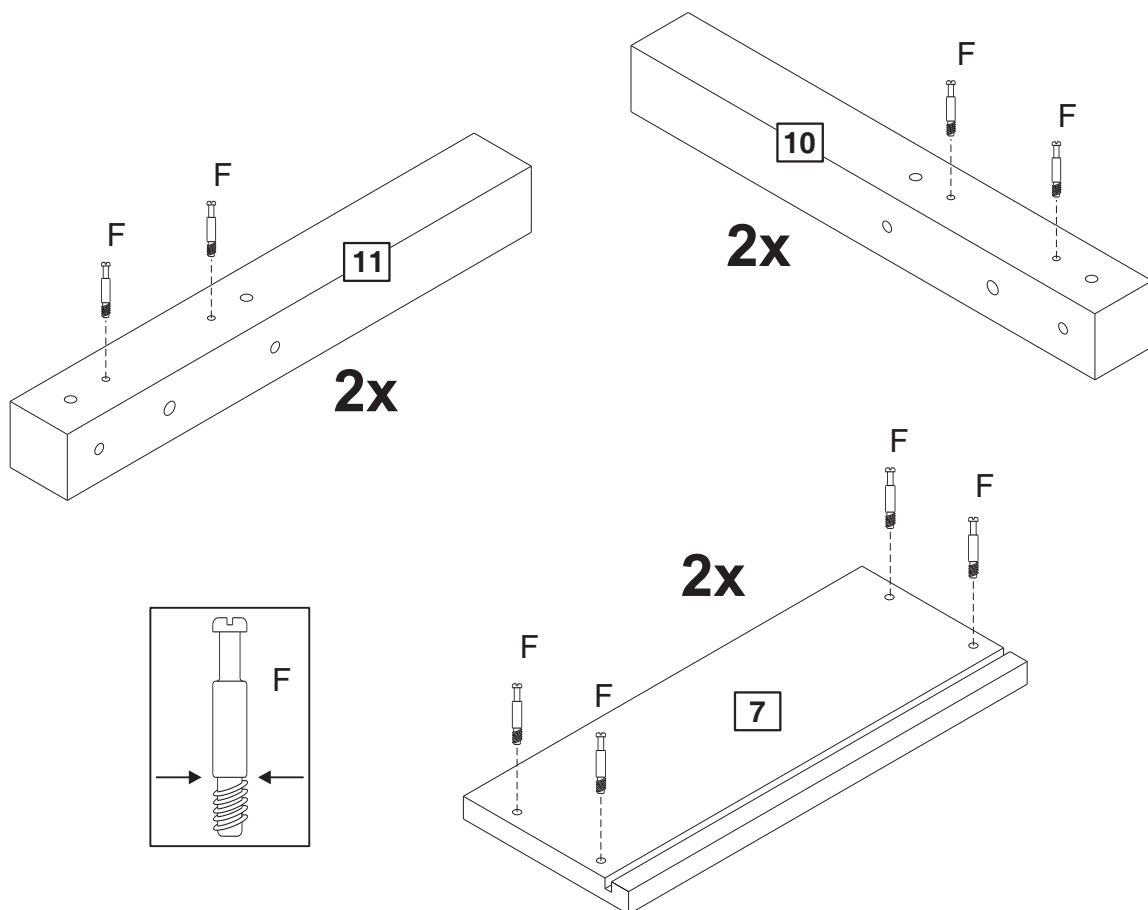
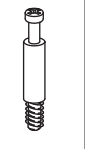

2

Fx16

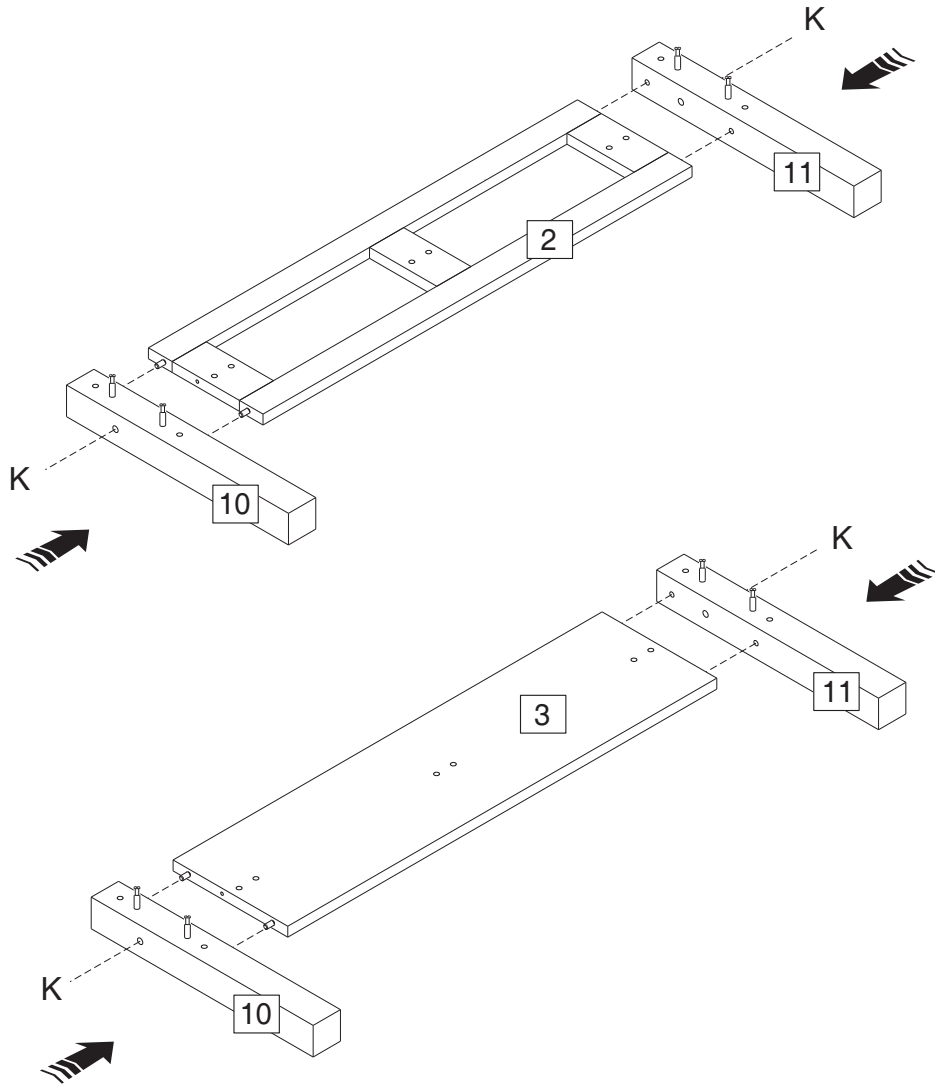

3

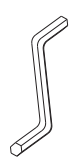

Kx4	Lx1
	
Ø7,0x90mm	

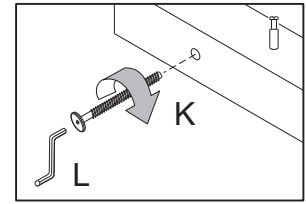

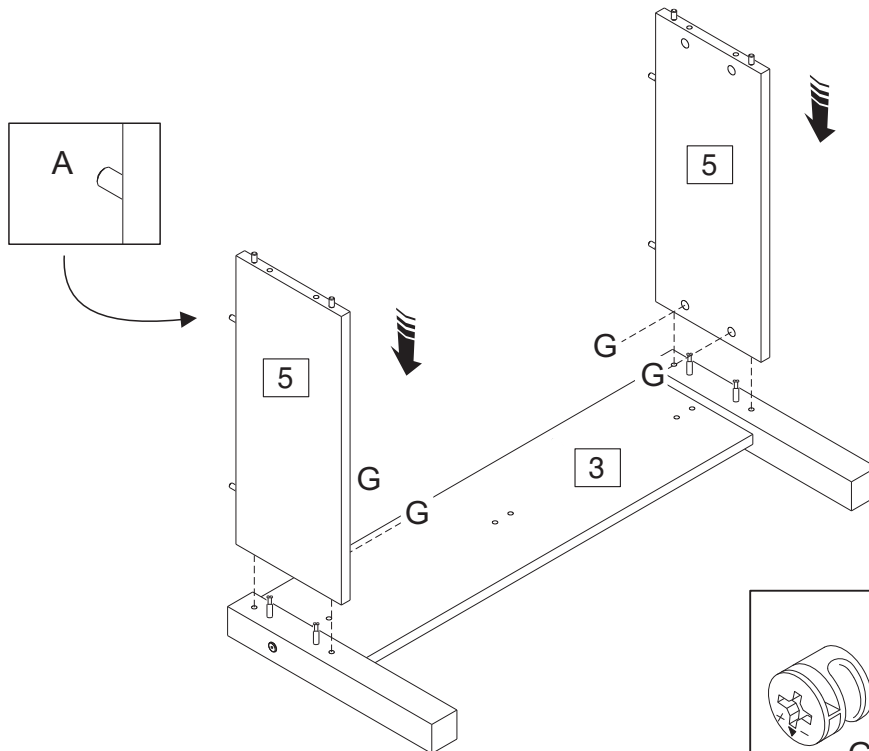

4

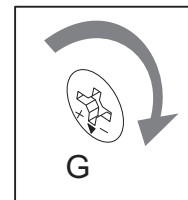
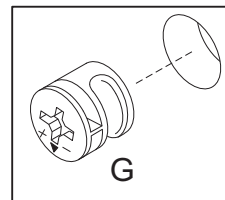

Gx4

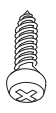

5

Bx12	Jx6
	
Ø3,5x14mm	

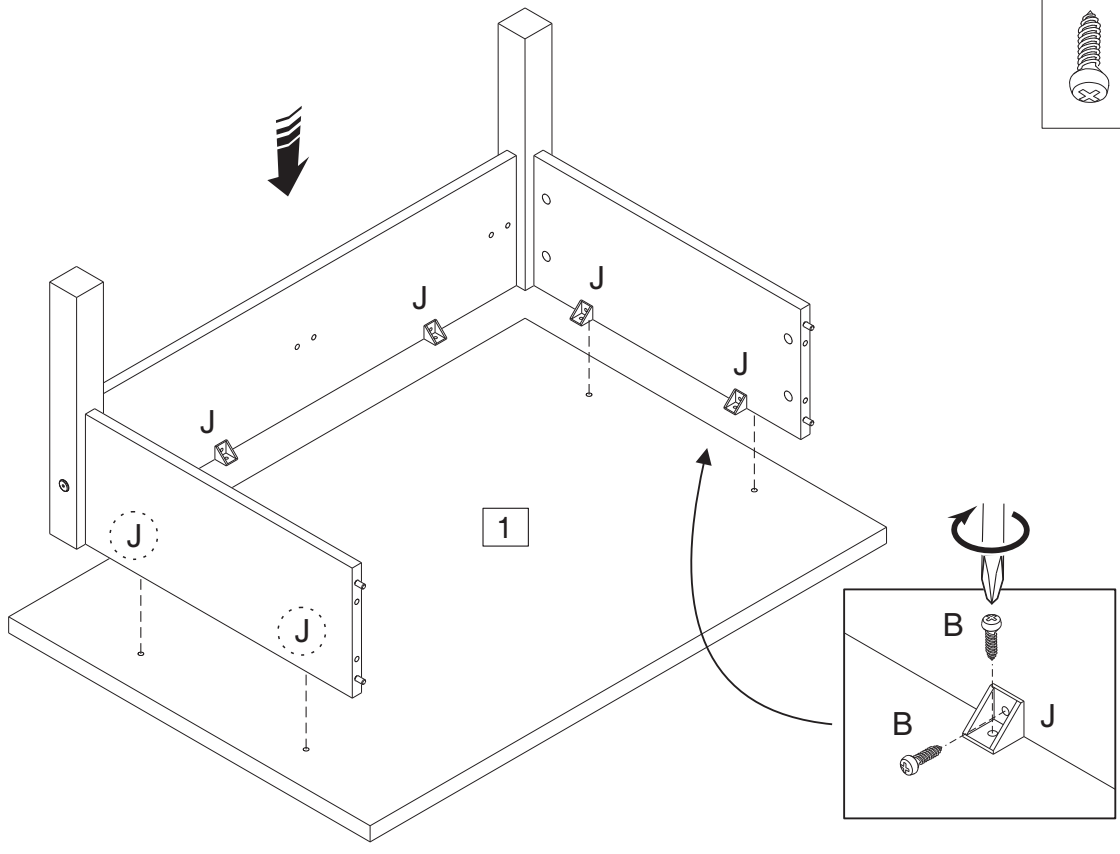

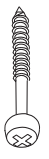

6

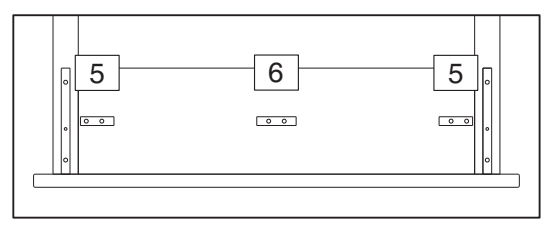
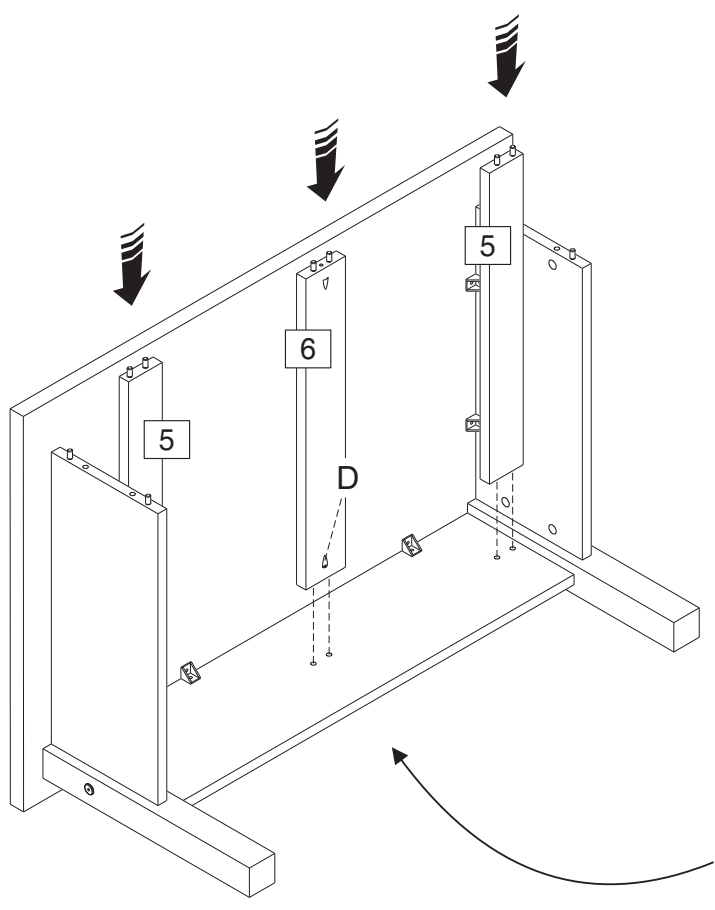
Dx1

Ø4,0x35mm

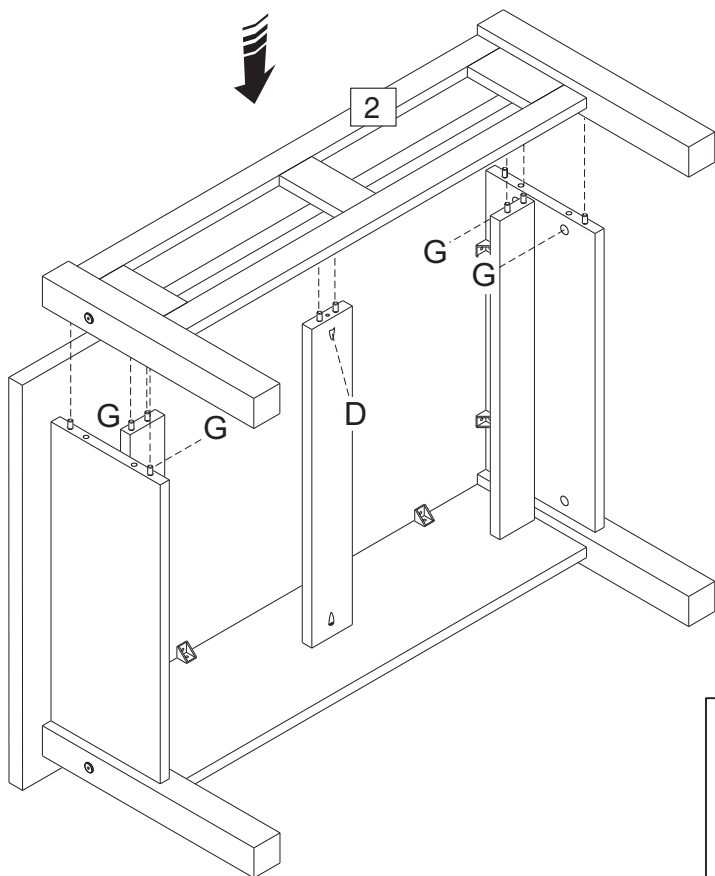

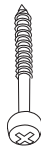
7



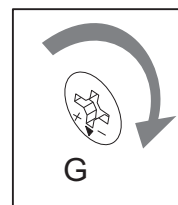
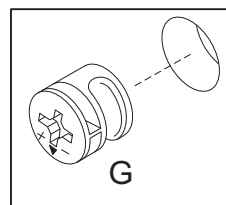

Dx1	Gx4
	
Ø4,0x35mm	

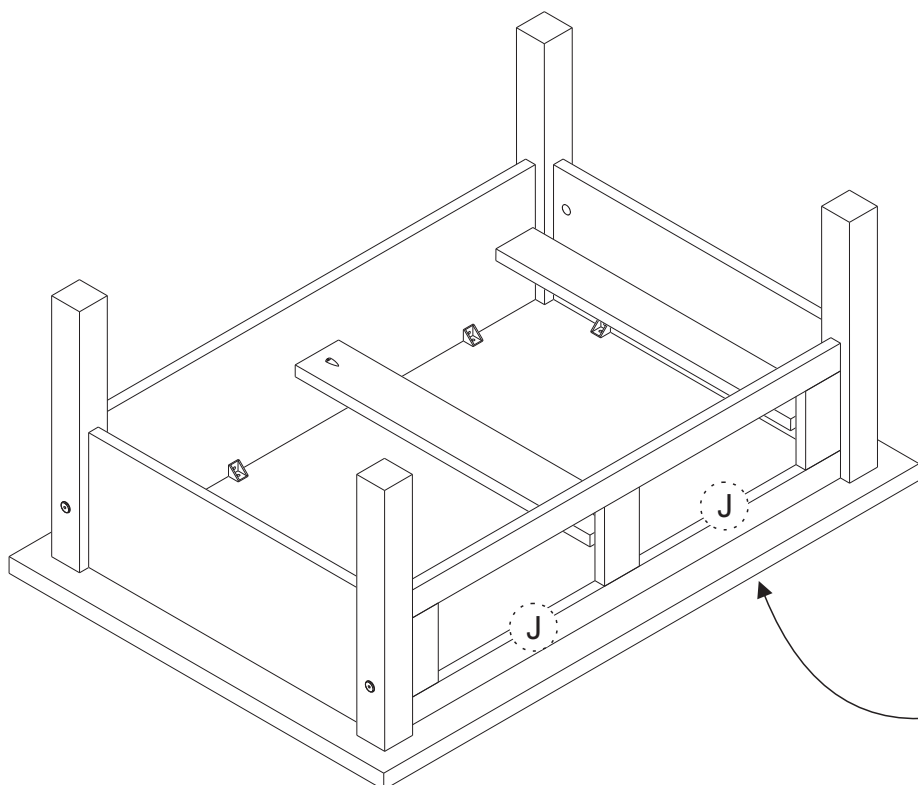

8



Bx4	Jx2
	
Ø3,5x14mm	

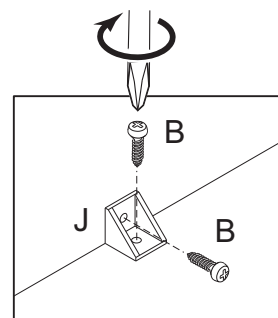

9



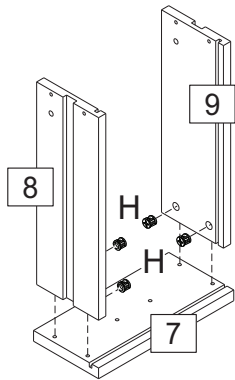

a:

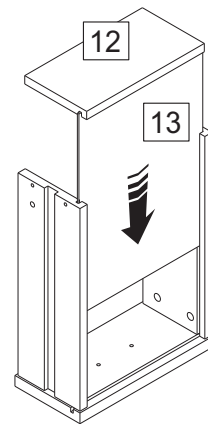

b:

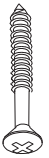

2x

Cx8	Ex4
 Ø3,5x30mm	 ØM4x16mm
Hx8	Ix2
	

c:

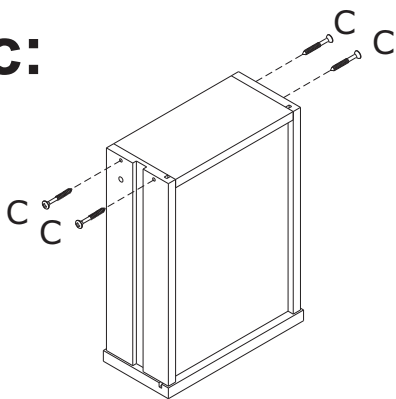

d:

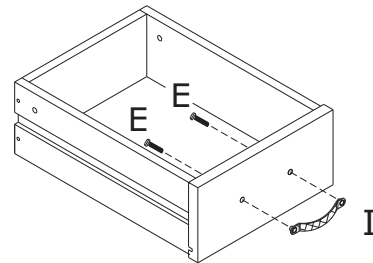

10

Ax4
 Ø8x30mm

