

Idea 67950

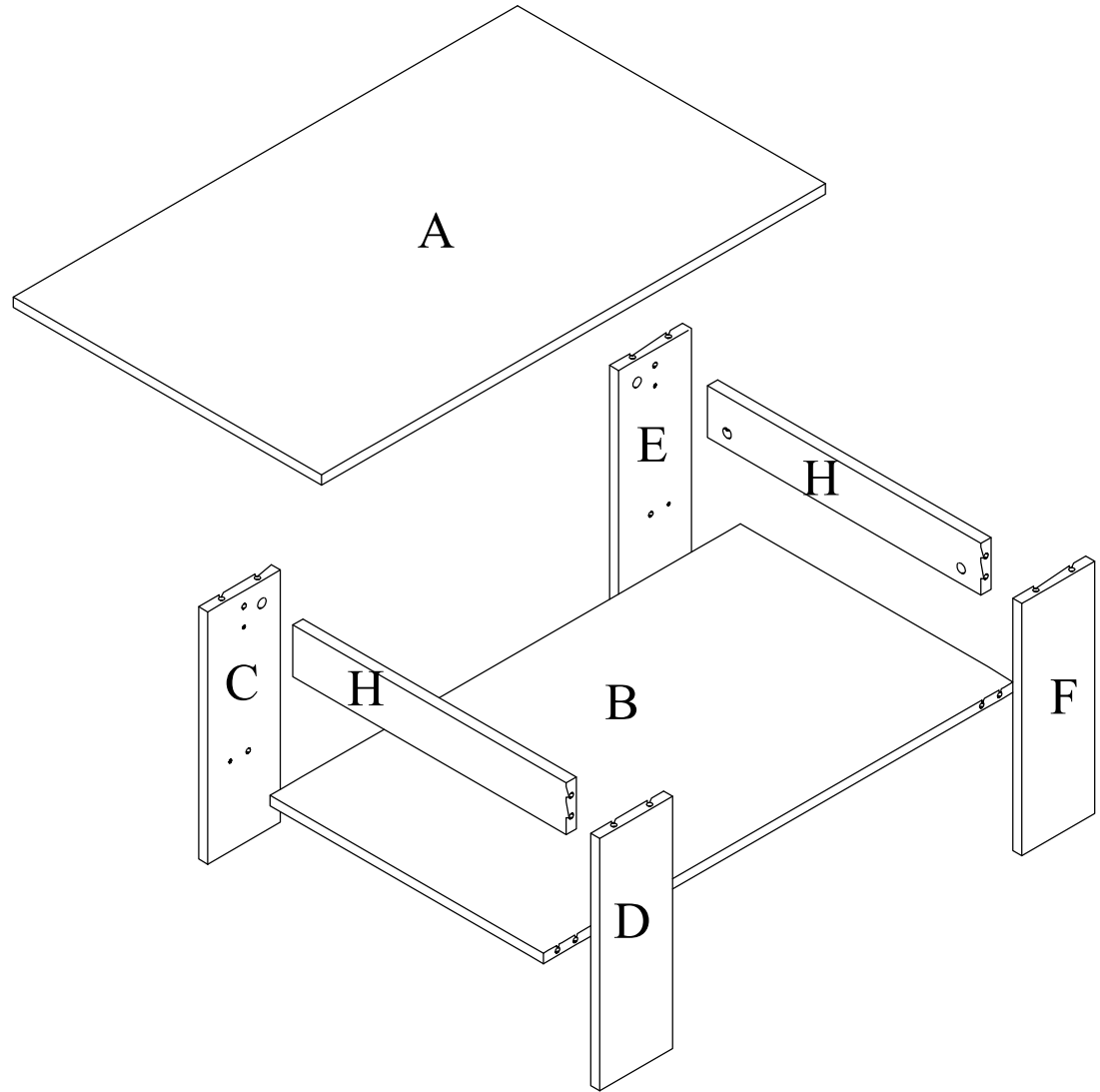

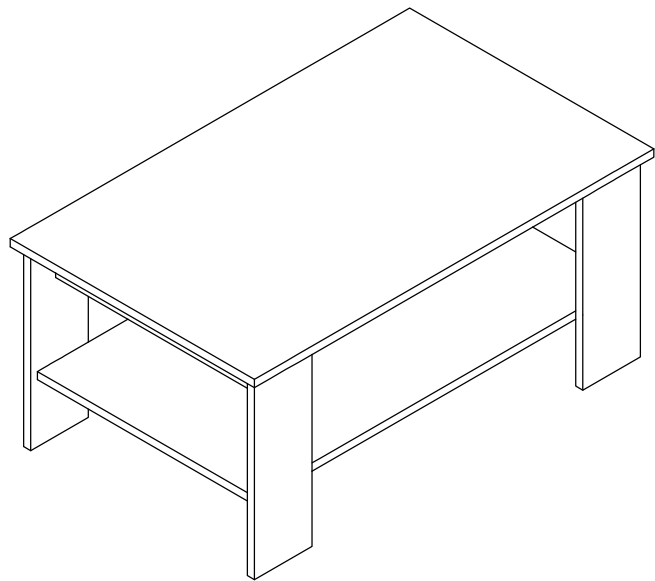

0013K	1x	0054K	4x	0018K	12x	0019K	12x
-------	----	-------	----	-------	-----	-------	-----

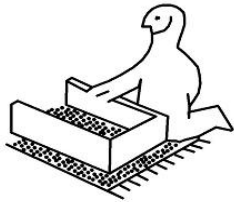
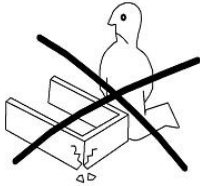
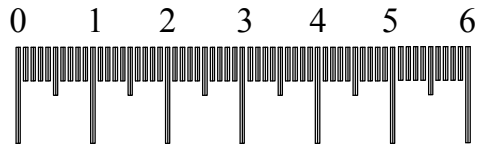
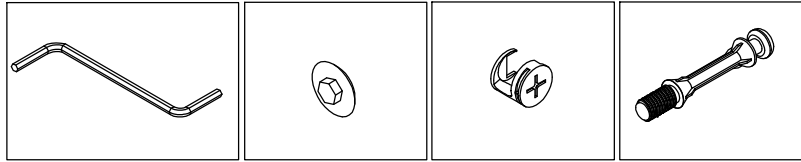

0002K	4x	0003V	8x	0001K	12x	1054K	8x
-------	----	-------	----	-------	-----	-------	----

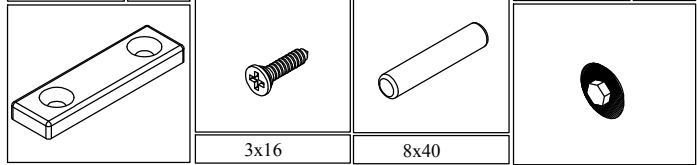

1.)

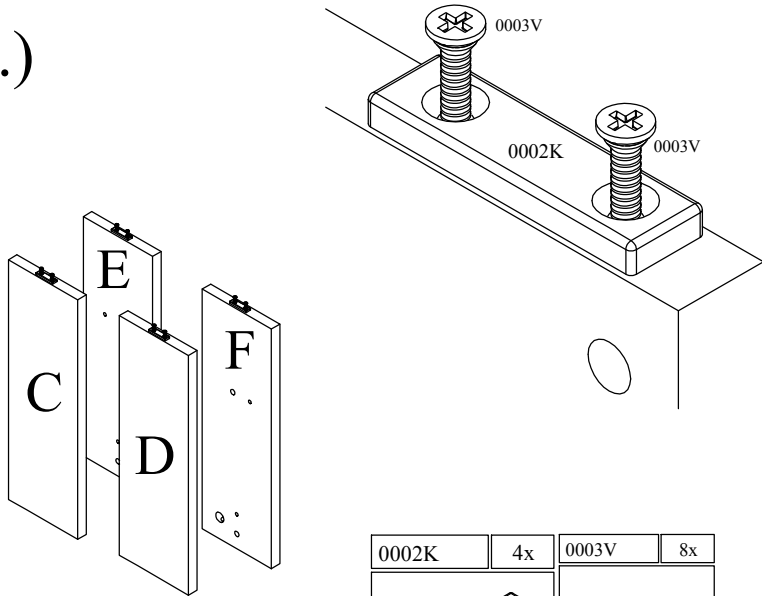

0002K	4x	0003V	8x
		3x16	

2.)

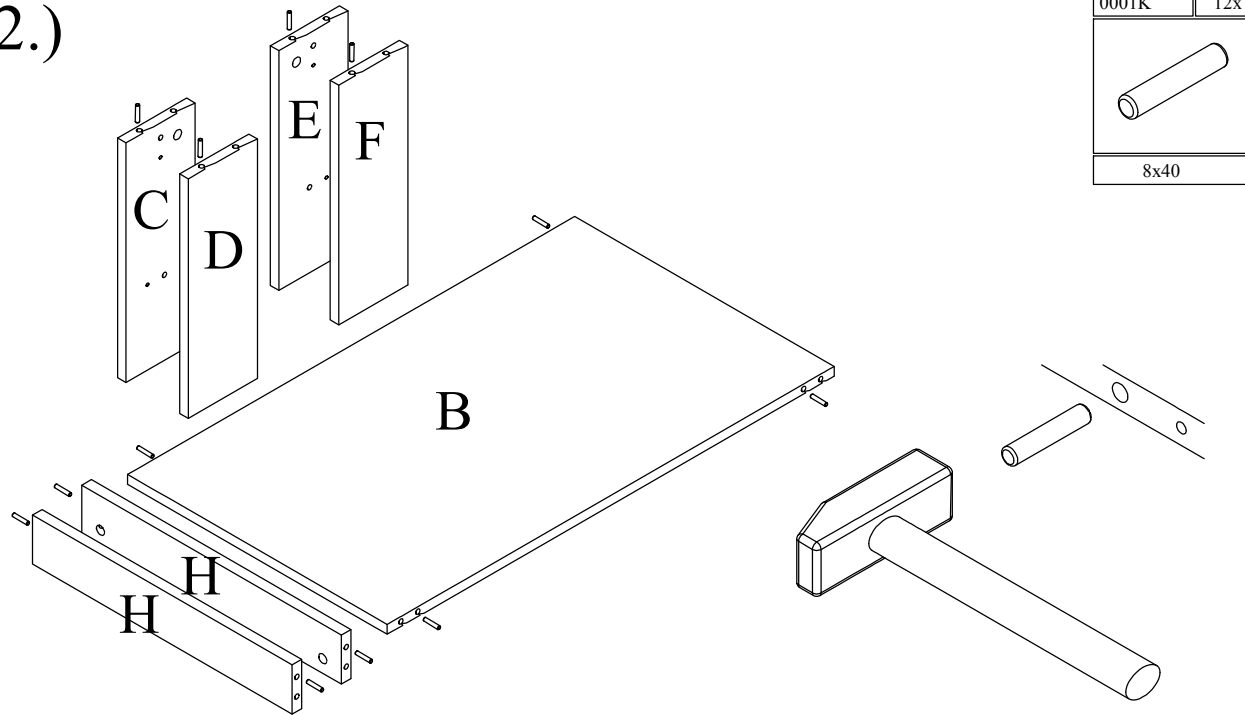

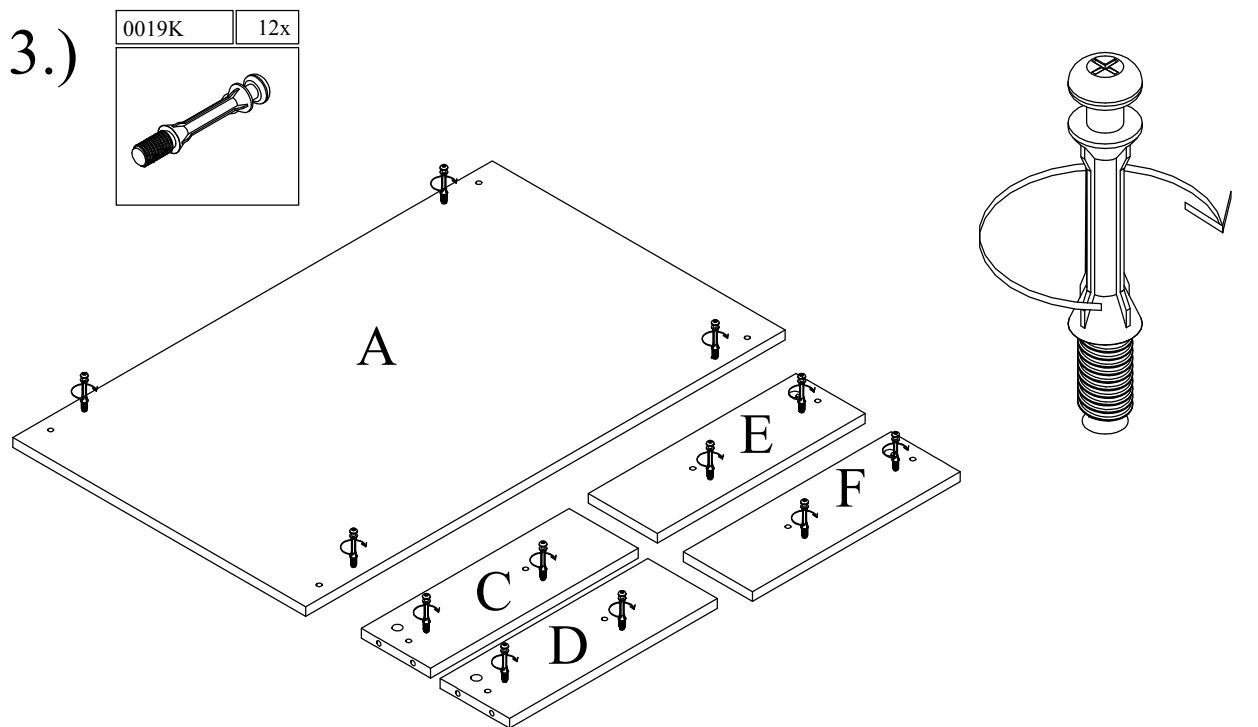

0001K	12x
8x40	

3.)

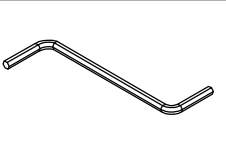
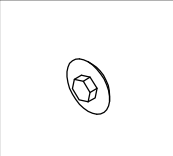

0019K	12x
-------	-----

4.)

0013K	1x	0054K	4x	0018K	8x
					

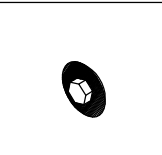
1054K	4x
	

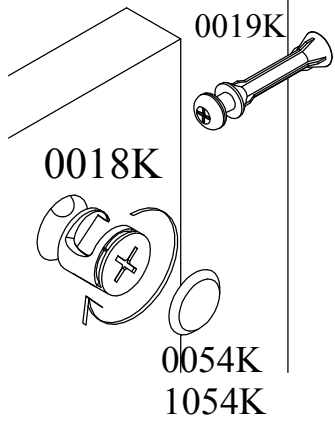
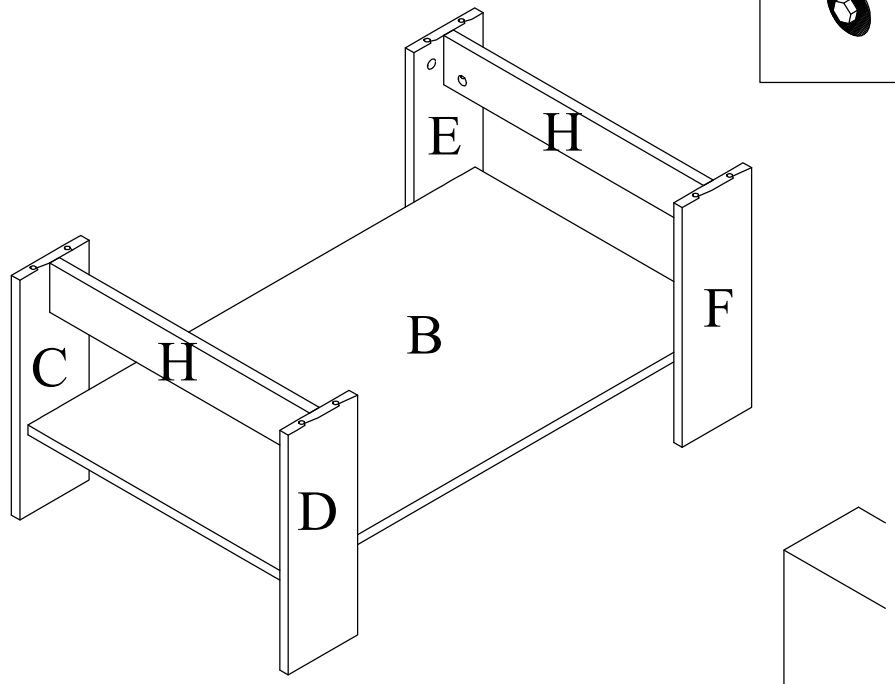

0013K	1x	1054K	4x	0018K	4x
